

A game by Alexander Pfister and Viktor Kobilke

SKYMINES

for 1 to 4 players, aged 12 and up

RULE BOOK



Intro

50 years ago, humanity began mining the Moon and the asteroids, and for decades that task was firmly kept in the hands of the World Government. But recent turmoil has caused this enterprise to collapse. Now, adventurous companies and private investors take to the sky to revive this mining network.



As investors, you try to earn the most CrypCoin over the course of seven rounds. You do this by investing mined resources in companies and by spreading outposts of these companies across the Moon (or the asteroids of the Belt) to increase their value. You can improve your earnings by supporting your scientists' research and by having them collect precious helium-3.



Components

1 double-sided game board



Front: Moon side



Back: Belt side

4 double-sided player boards



Front: Standard side



Back: Luna side

5 double-sided company tracks

Each side shows a different track and has an ID made up of a letter and a number (A1 to E2).



44 action cards



Front



Back

5 track cards



Front



Back

36 starting action cards (9 per player: ♦ ★ ▲ ○)



Front



Back

4 single-energy cards



Front



Back

4 bonus tiles



Front

Back

10 starting research tokens



Front

Back

8 ON/OFF markers



Front: ON side

Back: OFF side

72 research plans

24 A-research plans



Front

Back

24 B-research plans



Front

Back

24 C-research plans



Front

Back

6 special research plans



Front

Back

60 CrypCoin



40 x

20 x

4 player tokens

20 bonus markers (5 per player)

16 track markers (4 per player)

1 first player marker

60 outposts (15 per company)

4 helium-3 markers

4 upload markers

1 scoring pad

4 overview sheets

Front: Round overview

Back: Luna overview

Additional components

For simulating an additional player (see Luna booklet):

4 Luna tokens

For playing with the module "Mission cards" (see page 25):

12 one-time bonus markers (3 per player)

For playing with the Belt side of the board (see page 26):

20 shuttles (5 per company)

19 Luna cards

Front Back

6 mission cards

Front: mission card Back: mission status card

For playing with the module "Threat cards" on the Belt side (see page 30):

6 threat cards

Front Back: wild share

Folding boxes

For proper storage of the components, the game comes with 6 folding boxes.

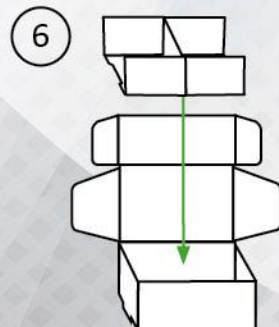
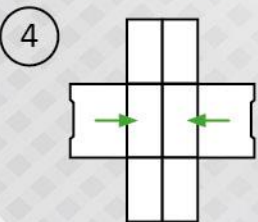
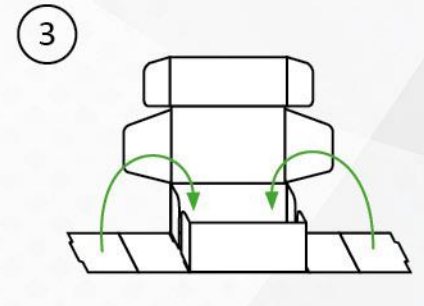
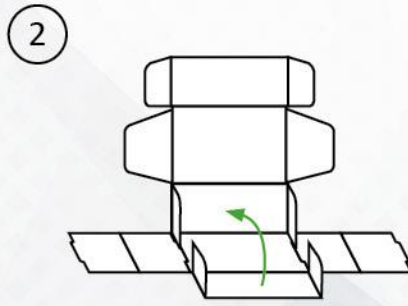
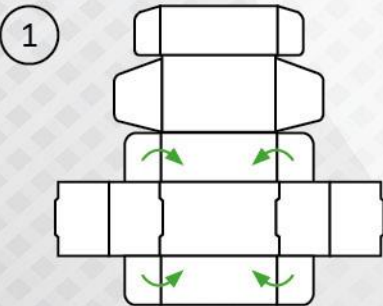

Setup

Below you find the setup and rules for the basic game of *Skymines*, which is played on the Moon side of the board.

We recommend playing the basic game once or twice first. Afterwards you could try the 4-chapter campaign (see page 24), which is an exciting challenge and introduces you to the additional modules of the game: the mission cards, the Belt side of the board, and the threat cards. If you would like to play any of those independently of the campaign, you'll find the additional rules for them specially marked throughout the pages of the campaign.

- 1** For the basic game, leave the following items in the game box:
the one-time bonus markers, the mission cards, the shuttles, and the threat cards.

Also leave the Luna cards and the Luna tokens in the game box. These items are only needed if you want to simulate an additional player (which is necessary in solo play or if you want to add competition to a 2- or 3-player game). The additional rules for playing with Luna can be found in the Luna booklet.

- 2** Place the **game board**, Moon side up, in the middle of the table.

- 3** Take the **company tracks** and set them up in one of the following ways:



A) In your first game, we recommend this default setup:

Take the **company tracks** with the sides **A1**, **B1**, **C1** and **D1** and place them at the colored parts of the board's edges as follows:

A1 at the yellow edge of Skymine Resources

B1 at the purple edge of Minerva Corp.

C1 at the pink edge of Astrogo Enterprises

D1 at the blue edge of Tawac Industries

B) If you want to play with a random setup, do the following:

Take the 5 **track cards** and shuffle them face down. Then place one of them face down next to each of the 4 edges of the board. Spin them a few times in place, before making sure that each card has one of its arrows clearly pointing towards the edge of its side of the board. Then flip all 4 cards face up and replace each with the company track shown on the card's half that is touching the board's edge.



C) If you prefer, you can also choose which track to place at which colored edge.

After the company tracks have been allotted, the spare company track and the 5 track cards are not needed any more. Return them to the game box.



Once you've allotted the company tracks, each of them is linked with its company for the remainder of the game. For example, if **A1** is placed at the yellow edge of Skymine Resources, it is called the Skymine track; if **B2** is placed at the pink edge of Astrogo Enterprises, it is called the Astrogo track, etc.

- 4** Place the 15 **outposts** of each color onto the **home spaces** of their matching **station**: the 15 yellow outposts in Skymine Station, the purple ones in Minerva Station, the pink ones in Astrogo Station, and the blue ones in Tawac Station. Make sure that in every station each home space (and any coin icon on it) is covered with an outpost.

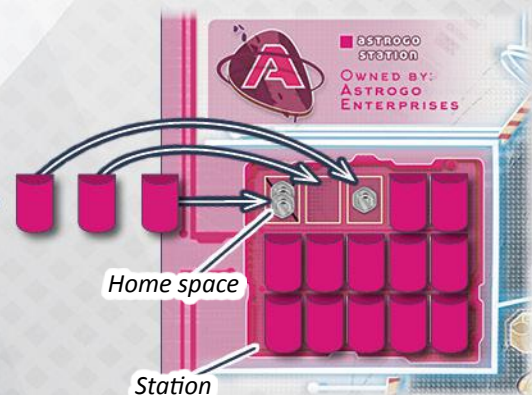

5 Sort the 44 **action cards** by the letter in the top right corner of each (A,B,C,D,E).

Shuffle the 4 cards of letter E and place them as a face-down stack next to the bottom left of the game board.

Then shuffle the 4 cards of letter D and place them face down on top of this stack.

Continue in this manner with the 11 cards of letter C, the 16 cards of letter B, and the 9 cards of letter A.

The resulting stack is called the **action card stack**.

Below it, leave room for the **action card discard pile**.



6 Now, fill the 12 spaces of the **card display** (numbered 1 to 12) with face-up cards drawn from the action card stack. Fill those spaces in ascending order, starting at space 1 in the top right corner and ending on space 12 in the bottom left.

7 Place the **CrypCoin** (of values 1 and 5) as a supply next to the game board. This supply is called the **bank**.



8 In the top right corner of the game board, set up the **research display** as follows:

1 Place 1 CrypCoin from the bank onto the **supplement space**.

2 Then take another 6 CrypCoin and place one onto each of the 6 **round track spaces** numbered 2 to 7. (Leave number 1 empty.)

3 Take the 6 **special research plans** and place one face down onto each of these 6 coins, starting with plan 2 on the leftmost coin and continuing right in ascending order.

4 Divide the other 72 **research plans** by the letter on their back (A,B,C). Shuffle them separately and place them as face-down stacks next to the top right side of the board to form the **research plan supply**.

5 Then fill each of the 12 lettered spaces in the research display with a face-up research plan of the matching letter from this supply.

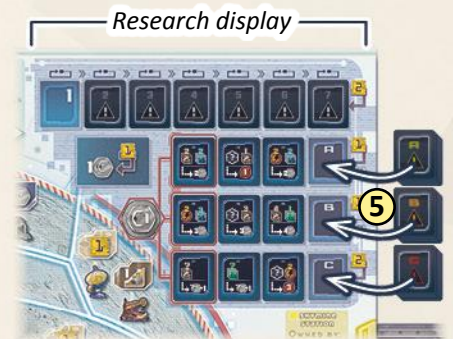
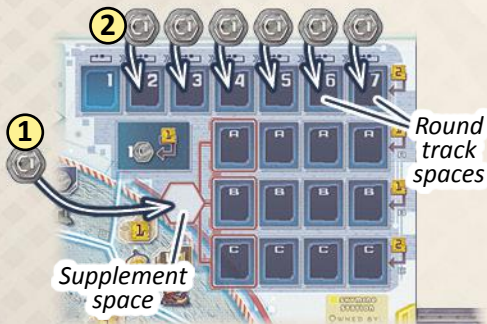

9 Place the 4 **bonus tiles** face up below the right side of the game board.



10

Each player: Choose a player color and take the corresponding **player token**. →

Then take the following items:

Take a **player board** and place it in front of you with the standard side up.
(Make sure that you leave room above and below your player board for cards.)

Then place your player token onto the computer screen in the top left corner.

Take 1 **helium-3 marker** and place it onto the first space of your **tank track** in the bottom left of your player board.

Take 2 **ON/OFF markers** and place them, OFF-side up, onto the **additional action slots** in the bottom corners: one on the left and one on the right.

Take 1 **upload marker** and place it below your player board.

Take 1 CrypCoin from the bank and place it as your starting capital next to your player board in your **reserve**.

Take **bonus markers** of your color and place them in your reserve:

In a 2-player game (and solo mode), take 3 bonus markers.

In a 3- or 4-player game, take 2 bonus markers.

Return your spare bonus markers to the game box, they are only used in games that include the company track A2.

Take the 4 **track markers** of your color and place one onto space 0 of each of the 4 company tracks.



Take the 9 **starting action cards** that are marked with the icon of your color in the upper right corner and put them in your hand.



Also take an overview sheet.

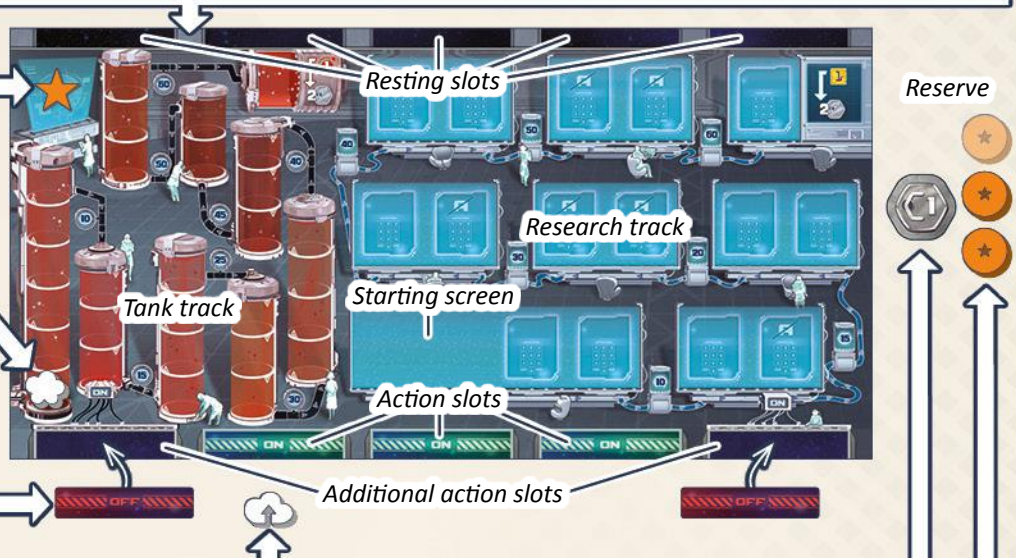

11

Determine a first player and give them the **first player marker**.

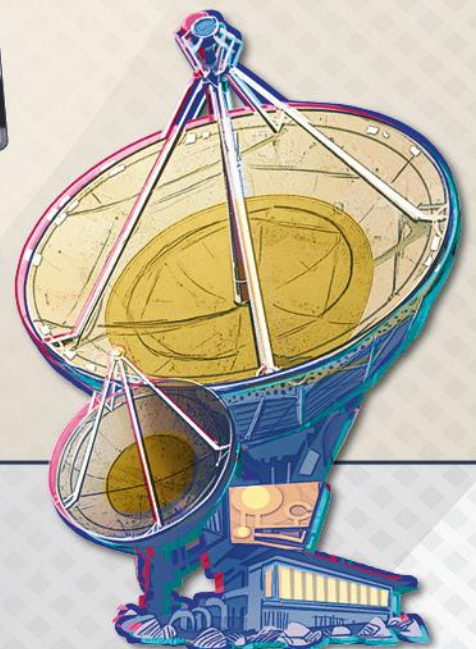

12

Give each player in clockwise seating order a specific **single-energy card**:

- The first player receives the single-energy card showing a **01** in the top right corner.
- The second player (if any) receives the single-energy card with the **02**.
- The third player (if any) receives the single-energy card with the **03**.
- The fourth player (if any) receives the single-energy card with the **04**.



Each player adds their single-energy card to their hand, bringing it to a total of 10 starting action cards. Return any spare single-energy cards to the box.

13

Now each player receives a **starting research token**.



A) In your first game, we recommend giving each player in clockwise seating order a specific starting research token:

- Give the first player this token:



- Give the second player (if any) this token:



- Give the third player (if any) this token:



- Give the fourth player (if any) this token:



Return the spare starting tokens to the game box.

B) If you know the game, you may use this random procedure:

Shuffle the 10 starting research tokens and deal each player two face down. Return any spares to the game box. Each player looks at their own two tokens, secretly chooses one of them and returns the other one to the game box. Then all players reveal their chosen token simultaneously.

Each player: After receiving your starting research token, carry out the following steps:

1. Place your starting research token face up onto the **starting screen** of your research track.



Start screen

2. Search your hand for the 3 cards whose icons match the 3 icons shown on your starting research token. Place them in any order in the 3 central **resting slots** at the top of your player board.



Resting slots

3. Gain the starting bonus in the bottom left of the token. (Your starting bonus refers to 1 or 2 specific tracks and the number of spaces you must move forward on these tracks with your marker.)



3 spaces on the Skymine track



2 spaces on the Minerva track

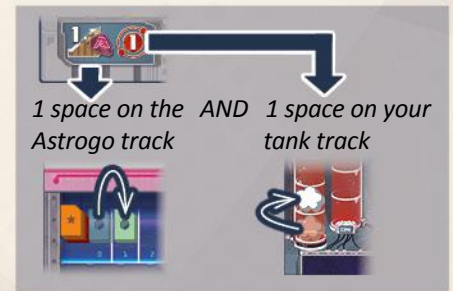

1 space on the Astrogo track AND 1 space on your tank track





4. Finally, place your upload marker onto the left half of your starting research token.



Object of the game

Your goal is to earn the most CrypCoin by investing resources in the 4 companies and by spreading their outposts across the Moon. By investing resources, you increase the number of shares you hold in a company and by spreading that company's outposts, you increase the value of each of its shares. Also, you can improve your earnings by storing helium-3 on your tank track and by uploading the research of your research track.

During the game, you gain CrypCoin in cash, which you mostly use to pay for certain actions. The main portion of CrypCoin, however, you earn at the end of the game. Then your wealth is calculated by summing:

- the cash you have on hand 
- the value of the shares you hold in each of the 4 companies 
- the last value your helium-3 marker has passed on your tank track 
- the last value your upload marker has passed on your research track (plus the face-up values of any uploaded special research plans) 

The player with highest total wins the game.

Company shares and their value

During the game, you can advance your marker on each company track. You own as many shares of a company as are shown on the last **share icon**  you reached on its track.

Also, some cards (which you can acquire during the game) may show an additional share of that company.

The value of each share equals the number of **coin icons** showing on its corresponding station. Thus, during the game, as outposts are removed from the station to be placed in the Moon's sectors, the value increases.

Example: Lin (♦) has a total of 7 shares of Minerva Corp.: 5 shares on the Minerva track and 2 shares on cards.



As each share has a value of 6 CrypCoin (because 6 coin icons are visible in Minerva station), Lin's shares of Minerva Corp. are worth a total of 42 CrypCoin (7 shares x 6 coin icons = 42).

Playing the game

Skymines is played over 7 rounds ().

Each round consists of 3 phases:

- 1) Planning phase (see page 10)
- 2) Action phase (see pages 10 to 18)
- 3) Preparation phase for the next round (see pages 18 and 19)

After the Action phase of round 7, the game ends with a **Final scoring phase**. (see pages 19 and 20)

Note: The current round is always indicated by the highest **large** white number on the **round track**. At the start of the game, the first round track space is empty to indicate the first round. In subsequent rounds, the new round will be indicated by flipping the next special research plan face up (during phase 3).



1) Planning phase

The Planning phase is carried out by all players **simultaneously** and comprises 2 steps:

- a) Each player plans their Action phase by placing cards face down in their action area
- b) All players turn their placed cards face up

a) Place cards face down in your action area

Each player: Choose cards from your hand and place them **face down** in the available **action slots** of your **action area** (the area **below** your player board).

Note: You will use the cards in your action area during the Action phase. Thus, the cards you place will determine to a certain extent which actions you can perform (see pages 11 to 16 for details of the cards and their actions).

At the start of the game, you have **3 action slots** available (the 3 slots marked "ON" at the bottom of your player board).

Each available action slot can hold 1 card. Therefore, you can place up to 3 cards.

Later in the game, you may switch on one or even two **additional action slots** by reaching certain spaces on your tank track and your research track (see page 23). As each switched-on slot lets you place a card, you could place up to 5 cards if you had switched on both additional action slots.

- Which card you place in which slot is up to you.
- You can place fewer cards than allowed.

Be aware, that the cards that you use in a round won't be available to you again for a while: at the end of your action phase, you must move each card from its action slot to a different one of your **resting slots**. The cards that gather in each resting slot are called a **resting deck**. They are inactive and cannot be used until they are recovered. However, each round, you can only return one resting deck to your hand (see "Drop out of action phase" on page 18).

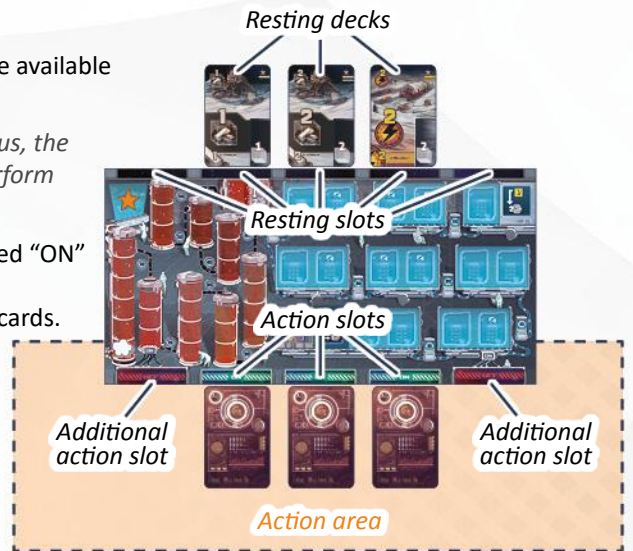

Note: For a more challenging variant, in which each action slot is linked to the resting slot in the same vertical line, see page 23.

b) Flip cards face up

Once all players are finished placing cards, everyone flips their cards face up.

2) Action phase

The player with the first player marker begins the Action phase by taking one turn. Then the player to their left takes one turn, then the next player and so on. In this manner, the Action phase proceeds turn by turn in a clockwise direction until all players have dropped out of the Action phase.

When it is your turn, you **must** perform **exactly ONE** of the following actions:

- 1) Use **1 or more resource cards of a single type** in your action area (page 11)
- 2) Use **all energy cards** in your action area (pages 12 and 13)
- 3) Use **1 research scientist card** in your action area (pages 14 and 15)
- 4) Use **1 field scientist card** in your action area (page 16)
- 5) Place **1 bonus marker** (pages 16 and 17)
- 6) Drop out of Action phase (page 18)

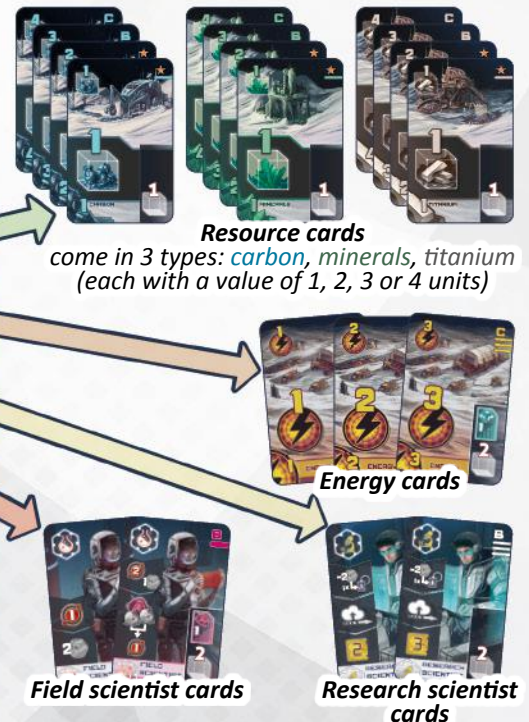

Once all players have performed the "Drop out of Action phase" action, the Action phase ends.

The cards you placed in the Planning phase determine what actions are available to you in the Action phase.

After you have used a card for an action, you **must** flip it face down (to indicate that you have used it). Flipped cards cannot be used again this round.

Example: On her turn, *Lin* cannot perform the "Use all energy cards" action as she has not placed any energy cards in her action area. (The energy cards in her resting slots do not count, because they are inactive.)



Example: After using her research scientist card, *Lin* flips it face down.



1) Use 1 or more resource cards of a single type in your action area

With this action, you can **acquire a new card** from the card display and **advance your markers** on the company tracks.

To perform this action, choose from your action area any number of face up resource cards of the **same type** (carbon, minerals or titanium). You must choose at least one card, irrespective of how many resource cards of this type you have and which value each of them shows. The values of your chosen cards add up to form your **resource value**, which you must use to:

- Acquire a maximum of **1 card** from the card display AND/OR
- Advance on 1 or more company tracks with your track marker(s).

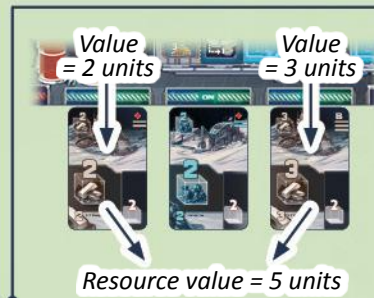

Example:

To perform this action, *Lin* could use:

- the single 2-unit titanium card
- OR • the single 3-unit titanium card
- OR • the 2-unit titanium card and the 3-unit titanium card combined to form a resource value of 5 units
- OR • the 2-unit carbon card

Acquire 1 card from the card display

Acquire 1 card of your choice from the card display. Each card's **total cost** equals its printed **cost** plus the cost on the game board to its right. Your resource value must meet or exceed this total cost.

If your resource value equals the total cost, take the card from the display and put it **in your hand**.

If your resource value exceeds the total cost, take the card into your hand and use the **remaining** units to advance on 1 or more company tracks (see below).

Attention: The card display is not refilled until the end of the round.



Advance on 1 or more company tracks

Use your resource value (or the remaining units if you acquired a card) to advance on company tracks. For **each unit**, move one of your track markers **1 space forward**. Do so until you have used up all units. You can split up your units in any way you want, using all of them on the same company track or dividing them among different tracks. (See pages 21 to 23 for details of the company tracks.)

Once you are finished, flip each card that added to the resource value face down. Then your turn ends.

Example: *Lin* (♦) uses a resource value of 5 units (by combining the 2-unit titanium card and one of the 3-unit titanium cards).



For a card price of 4 units, she acquires the 2-unit minerals card from the display and puts it into her hand. As she has 1 unit left, she uses it to advance 1 space on a company track of her choice.





Finally, she flips the used titanium cards in her action area face down.



2) Use all energy cards in your action area

With this action, you can spend energy to **expand a company** by entering new sectors of the Moon with its outposts.

To perform this action, you must use **all** energy cards in your action area at once. You may **not** keep any of them for a later turn.

Each energy card shows a number of **energy points** (,  or ). Add up the energy points of all energy cards in your action area and use that total to expand **1 company**. Which company you expand is up to you (but you may not divide your energy points among more than 1 company).

Note: It doesn't matter if any of the energy cards you use show an additional share of any company. These additional shares only matter in the Final scoring phase.

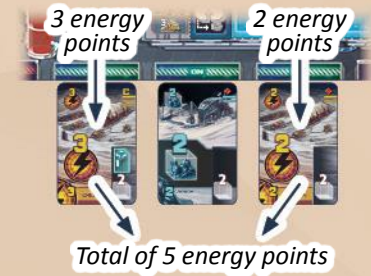

First, choose a company. Then spend your energy points to enter new sectors with outposts taken from that company's station. The 24 **sectors** are separated from one another and the stations by **single lines** or **double lines**. Entering a sector consumes either 1, 2 or 3 energy points (see below for details). Once you have spent all energy points, you receive the **rewards** of the sectors you entered. Then your turn ends.

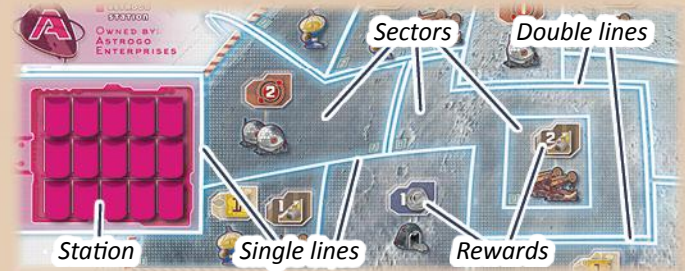

To enter a sector, carry out the following steps:

- Choose which sector you want to enter. This sector must be **adjacent** to either the expanding company's **station** OR to **any** sector that contains an outpost of the expanding company. **Important:** The sector you choose can contain an outpost of **another** company but not of the expanding company itself.
- Check how many energy points entering the sector consumes (going out from the adjacent station/sector of the expanding company). If you only have to cross a **single line** to enter it, it consumes **1 energy point**. If you have to cross a **double line**, it consumes **2 energy points**. And if there is already an **outpost** of another company in the sector, entering it consumes **1 additional energy point**.

- If you have enough energy points to enter the sector, take **1 outpost** from the expanding company's station. Note, that each station comprises 3 **columns** of 5 home spaces each. You can take the outpost from any of the station's columns, but only from the top of that column (closest to the game board's center).

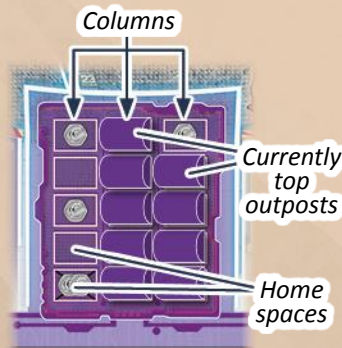

- Place the outpost in the sector. However, place it on its hemispheric side, so that it stands upright. (This is to mark that you have entered the sector but have not yet received its rewards.)



Repeat steps 1 to 4 until you've spent all your energy points. If you cannot or do not want to spend all of them, you must forfeit any excess.

Example:

Lin uses her total of 5 energy points to expand Minerva Corp.



First, she enters sector **21**, which consumes 1 energy point, as she has to cross the single line **a** to reach it. She marks entering the sector by taking an outpost (**a**) from Minerva Station and placing it upright in the sector.

Next, she chooses to enter sector **16**, which also consumes 1 energy point (for crossing the single line **b**). Again, she marks this with an outpost (**b**) taken from Minerva Station.

















Finally, she enters sector **24**, which consumes her remaining 3 energy points (2 for crossing the double line **c** and 1 more because a yellow outpost is already there). Then **Lin** also marks this sector by placing an outpost (**c**) from Minerva Station in it.



Once you have finished spending your energy points, carry out the following steps:

1. Gain the **reward** of each **structure** in the sectors you just entered. Take the rewards in any order, regardless of the order in which you entered the sectors.
2. Oust any outposts that were already in the sectors you entered. Return each of them to a vacant home space of its station. You may choose which column to place the outpost in, but it must go to the lowest vacant space of that column. However, you can never return an outpost to the *crossed out home space* of a column (the 5th space at the bottom). Once that's been revealed, it stays revealed for the entire game. Instead, return the outpost to the next vacant space above it.
3. Once any ousted outposts have been returned to their stations (there can be no more than one outpost in each sector now), tip over the upright outposts.
4. Finally, flip all energy cards in your action area face down. Then your turn ends.

The structures and their rewards:

<p>Deep mine</p> <p>Gain from the bank:</p> <p>1 CrypCoin  2 CrypCoin </p>  	<p>Strip mine</p> <p>On the track of the company you just expanded, move your marker forward:</p> <p>1 space  2 spaces </p>  
<p>Gas collector</p> <p>On your tank track, move your helium-3 marker forward:</p> <p>1 space  2 spaces </p>   <p>Follow the arrows of your tanks. If you move it through a pipe, follow the arrows to the next tank.</p> 	<p>Research station</p> <p>Sum the research points shown above the research stations in the sectors you just entered. Utilize them to immediately acquire research plans from the research display and/or CrypCoin from the bank. (See the next page on how to utilize research points in detail.)</p>     

Example (continued):

After *Lin* finishes expanding *Minerva Corp.* into sectors 21, 16 and 24, she gains the rewards of their structures: she gains 1 CrypCoin from the bank and utilizes 3 research points (see next page). Then she ousts the yellow outpost back to *Skymine Station*, lowers any upright outposts and flips the energy cards in her action area face down.



Further notes and special cases:

- There are 2 **enclave sectors** on the Moon. Each of them is entirely surrounded by another sector. Thus, before you can enter an enclave sector, you must first have entered its surrounding sector.
- If there are no outposts left in a station, you cannot expand this company until outposts are returned by ousting. If a station runs out of outposts while you expand its company, you must forfeit any remaining energy points.
- If you need to return an ousted outpost to its station but there is no valid vacant home space left, remove the outpost from the game entirely.
- If you only have one energy card and its energy points are not enough to enter any sector, you must forfeit them entirely.
- In each column of a station, the crossed out home space is the most valuable as it shows 2 coin icons and cannot be covered again. Thus, when expanding a company, it is usually advisable to empty a column entirely before starting to empty the next column. However, if you have good reasons, emptying the columns evenly can also be a viable option.
- It does not matter if an outpost in a sector has any connection to its station, you are still allowed to enter a sector adjacent to this outpost's sector when expanding its company.
- Stations are not sectors and thus cannot be entered.

Before you learn about the “Use 1 research scientist card” action (which is used to advance your upload marker on your research track), you first need to know about **research plans and research points**:

Your upload marker can only enter a screen of your research track if there is a research plan on it. This means that in order to move forward on your research track at all, you must gradually fill its screens with research plans from the research display. (Each player already starts with 1 research plan on their starting research token.)

To acquire research plans from the research display, you need **research points**. You might get research points when expanding a company (see the previous pages), by using a research scientist card or through certain bonuses.

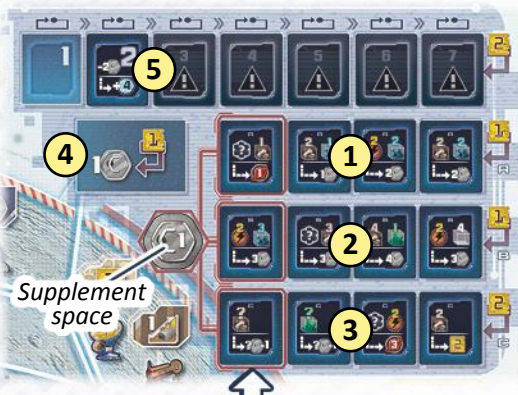

However, you cannot save research points up. Whenever you receive any, you must **utilize** them right away by spending their total on **any** of the following:

- ① Take 1 **A-research plan** from the research display (cost: 1 research point).
- ② Take 1 **B-research plan** from the research display (cost: 1 research point).
- ③ Take 1 **C-research plan** from the research display (cost: 2 research points).
- ④ Gain 1 **CrypCoin** from the bank (cost: 1 research point).
- ⑤ Take 1 **face-up special research plan** from the round track (cost: 2 research points).
Note: The first special research plan becomes available in round 2. Then each round, a new one is revealed.

If you take a research plan from any of the 3 red-framed spaces linked to the **supplement space**, also take any CrypCoin on that supplement space. (*Note: Each round, only 1 CrypCoin is added to it.*)

At the end of your turn, after you have utilized all your research points, carry out the following two steps if you acquired any research plans:

1. Place each plan you acquired onto **any** screen on your research track. However, there are a few things to consider:

- You are **not** allowed to place an A-research plan onto an empty screen that shows a crossed out A. (Only B-, C- and special research plans may be placed onto these screens.)
- You need research plans if you want to advance on your research track. Advancing is described on the next page. For now, you just need to know that research plans show requirements which you must meet with the cards in your action area. The better the requirements of the different plans fit together, the easier it is for you to fulfill several of the research plans at once and advance quicker on the track. Since you cannot skip empty screens, it usually is advisable to fill the screens of the track from front to back. However, planning ahead and trying to place research plans with similar requirements next to each other can be a good reason to place research plans farther up the track.
- Once placed, research plans cannot be removed from the track, though they may be flipped (see the bottom of this page).
- You are allowed to place a newly acquired research plan on top of any research plan that is already on your track (irrespective of its type/letter).



2. After placing the acquired research plans onto your research track, fill each of the now empty lettered spaces in the research display with a face-up research plan of the **matching letter** from the research plan supply. Any empty round track spaces remain empty.

Example: Expanding a company, *Lin* has entered a sector that gives a research point reward of 1 and a sector that gives 2. As she collects her rewards, she utilizes this total of 3 research points to take two A-research plans from the research display and 1 CrypCoin from the bank.



At the end of her turn, she places these two research plans onto her research track:



Then she refills the 2 empty spaces of the research display with face-up A-research plans from the research plan supply.



3) Use 1 research scientist card in your action area

With this action, you can upload your research by **advancing your upload marker** on your research track. This may give you various rewards.

To perform this action, carry out the following steps:



1. Before moving your upload marker, you **may** pay 2 CrypCoin to the bank to flip 1 **research plan** on your research track face down (this includes the research plan on your starting research token).



2. Move your upload marker as far forward on your research track as you like, bearing in mind the following rules:

- You must move the upload marker forward plan by plan (in the direction indicated by the arrows of the screens and the cables). Before your upload marker can enter a research plan, however, you have to check whether you meet its requirements. Each research plan shows in its upper half 1 or 2 **requirements**. These requirements refer to the cards which you currently have face up **in your action area**. To meet a requirement, you must make sure that the **total value of the cards of this type** in your action area equals or exceeds the total value required. (The order of the requirements on the research plan is irrelevant.) If you meet all requirements of a research plan, you may enter it with your upload marker. Then you must check whether you meet the next plan's requirements. Again, if you do, you may move forward, and so on. This means each research plan is regarded separately - the requirements of the research plans are not cumulative. Also, the cards used to meet the requirements **are not used up**, so do **not** flip them.
- Special research plans have a different requirement as they have a CrypCoin cost instead: To enter a special research plan, you must pay as many CrypCoin to the bank as its requirement shows. *(Note: The big number in the top right corner shows in which round the special research plan becomes available.)*
- Research plans that have been flipped and thus have their back side up can simply be entered as they have no requirements.
- Empty screens of the research track can't be entered.
- If you cannot or do not want to move any farther, leave your upload marker on the research plan that you entered last. Then you receive the **reward** of this (and only this) research plan. Flipped research plans and special research plans give no rewards. However, special research plans increase the value of your research track at the **end of the game**.
- If you do not move forward during this step and thus do not enter any new research plan, you do not gain a reward.

Requirements



Reward



3. **After** you have finished moving your upload marker and have received the reward of the last research plan you entered (or have not moved at all), utilize the total number of research points shown on the research scientist card as usual.

Afterwards, flip the used research scientist card face down. Then your turn ends.

For a list of special requirements and rewards, see the section "Overview of selected icons" on page 32.

Attention: If you are planning to use a research scientist card for moving forward on your research track, make sure that you do so **before** taking an action that flips any of the required cards. Once flipped, they are not valid for the requirements.

Example: Lin uses the research scientist **①** in her action area. First, she chooses to pay 2 CrypCoin to flip the research plan **②** that requires her to have at least 2 energy points in her action area (which she does not have).

Then she moves her upload marker forward **③**, checking each research plan to see if she meets the requirements to enter it (i.e. if the total value required is present in her action area). To enter the special research plan **④**, she pays another 2 CrypCoin, then moves along. She finally stops on the sixth research plan **⑤** (as she cannot meet the requirements of the subsequent plan). She receives the sixth plan's reward (2 research points). After utilizing these 2 research points, she utilizes the 2 research points of her research scientist card **⑥** and then flips it. Since she managed to reach the fifth screen, she also switches on the additional action slot there **⑦** (see page 23). Then her turn ends.

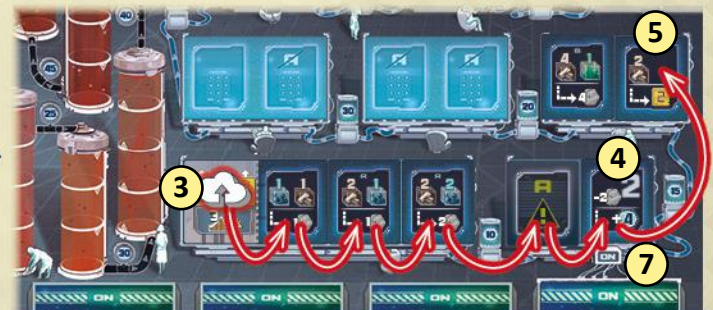



4) Use 1 field scientist card in your action area

With this action, you store helium-3 by **advancing your helium-3 marker** on your tank track. You also gain a few CrypCoin.

Note: Field scientist cards are the only action cards you have none of at the start of the game. There are 5 Field scientist cards in total which you can acquire from the card display during the game.

To perform this action, use 1 of the field scientist cards in your action area.

If you use this field scientist, move your helium-3 marker 1 space forward on your tank track AND gain 2 CrypCoin from the bank.



If you use this Astrogo field scientist, first move your helium-3 marker 2 spaces forward on your tank track AND gain 1 CrypCoin from the bank. Then check how many **gas collectors** are in the sectors controlled by Astrogo Enterprises (i.e. each sector that contains a pink outpost):

For every 2 gas collectors, move your helium-3 marker 1 additional space forward on your tank track.



After you've used your field scientist, flip it face down. Then your turn ends.

Example: Lin uses the Astrogo field scientist to move her helium-3 marker the basic 2 spaces forward and to take 1 CrypCoin from the bank. Then she checks the sectors controlled by Astrogo Enterprises for gas collectors. As there are 3 gas collectors, she moves her helium-3 marker 1 additional space forward. (If there were 4 gas collectors, she could move 2 spaces.)



5) Place 1 bonus marker

With this action, you can **place 1 of your bonus markers** onto a vacant bonus space, which gives you certain privileges or rewards.

To perform this action, take 1 of the bonus markers from your reserve and place it onto a **vacant bonus space**. Usually, each bonus space states a requirement or cost which you have to meet or pay in order to place your marker onto it. Depending on the space, you either receive its reward immediately or reserve for yourself a certain bonus tile for the next round.

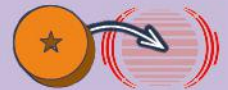

Once you have placed a bonus marker, it stays on that bonus space and blocks it for the rest of the round.

On the game board, you can find the following bonus spaces:

Majority bonus spaces



Standard bonus spaces



Bonus tile spaces



Majority bonus spaces



Requirement: You are only allowed to place your bonus marker onto this bonus space if **currently** no other player has **more research scientist cards** face up in their **action area** than you.

Reward:

- If you have 1 research scientist card in your action area, gain 2 CrypCoin from the bank.
- If you have 1 research scientist card AND in addition another scientist card (no matter if it is a research scientist or field scientist), gain 2 CrypCoin from the bank AND utilize 1 research point.
- If you have 1 research scientist card AND in addition at least two others scientist cards (no matter if those are research scientists and/or field scientists), gain 3 CrypCoin from the bank AND utilize 2 research points.



Requirement: You are only allowed to place your bonus marker onto this bonus space if **currently** no other player has a **higher** total value of **titanium** face up in their **action area** than you.

Reward:

- If you have a total value of at least 2 titanium units, you may move your marker on the **Astrogo track** 2 spaces forward.
- If you have a total value of at least 4 titanium units, you may instead move your marker on the **Astrogo track** 3 spaces forward AND remove an outpost from a station of your choice. (See page 32 for details of this reward.)
- If you have a total value of at least 6 titanium units, you may instead move your marker on the **Astrogo track** 4 spaces forward AND utilize 1 research point.



Each of the other 3 majority bonus spaces works just like the titanium majority bonus space: You may only place your bonus marker onto such a majority bonus space if **currently** no other player has a higher total value of the required type (resource units/energy points) face up in their action area than you.

Depending on your total value of the required type, you gain a certain reward which includes moving forward on a **specific** company track and may include an additional reward (like gaining 1 CrypCoin).

You may choose the reward of a lesser total value than you have. (For example, even if you have 6 minerals units in your action area, you still may take the "4+" minerals reward instead of the "6+" minerals reward).

Important: Gaining the reward of a majority bonus space does **not** use up the cards in your action area, so do not flip them.

Example: In a 3-player game, **Lin** (♦) wants to place one of her bonus markers onto the **minerals** majority bonus space. First, she checks whether she is allowed to do so. She has a total value of 5 minerals units. **Malik** (○) has a total value of only 3 minerals units and **Amber** (★) also has a total value of 5 minerals units. Since no other player has a higher total value, **Lin** is allowed to place her bonus marker.

She immediately moves 3 spaces forward on the **Minerva track** and 1 space forward on her **tank track**.

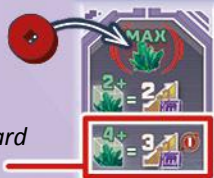

Standard bonus spaces



Requirement: You are not allowed to place your bonus marker onto this bonus space if you are the **first player** AND this is your very first turn of a round. (In later turns, you may place your marker here.)

Reward: Immediately take (or keep) the first player marker (i.e. you will be the first player of the next round). This is the only way the first player changes in the game. Also utilize 1 research point.



Requirement: Pay 1 CrypCoin to the bank.

Reward: Immediately buy 1 card from the card display by paying its total cost in CrypCoin to the bank. This is the only way to acquire cards for money instead of resources. Take the card into your hand.

Example: After paying 1 CrypCoin to place her bonus marker onto this bonus space, **Lin** acquires the 2-unit titanium card from the card display by paying 3 CrypCoin to the bank.



Requirement: Remove 1 card from **your hand** by placing it face up onto the action card discard pile.

Reward: Immediately gain an amount of CrypCoin from the bank equal to the cost printed on the removed card + 2.

Example: **Lin** removes the 1-unit carbon card from her hand and discards it. For this, she gains 3 CrypCoin from the bank.



Bonus tile spaces

Requirement: Pay to the bank the amount of CrypCoin shown (1 or 2).



Reward: There is no immediate effect, but you reserve the corresponding bonus tile for the **next** round. You are **not** allowed to take it right away! (See page 20 for the details of bonus tiles.)

Note: This icon indicates that you get the reserved bonus tile in the "Preparation phase for the next round".

6) Drop out of Action phase

Perform this action only if you cannot or do not want to perform any of the other actions.

To perform this action, carry out the following steps:

- Turn the face-down cards of your action area face up.
 - Pick up **exactly 1 of your resting decks**. In the first round, each resting deck comprises only one card. Later, resting decks may comprise several cards. Take all cards of your chosen resting deck into your hand.
 - Then, clean up your action area by moving each card in your action slots to a **different** resting slot of your choice (you can't move more than one of them to the same slot). If there is already a resting deck at a resting slot, place the new card offset on top, creating an overlapping column in which the bottom of each card is visible.
- Finally, return any **bonus tiles** in your action area to the area below the right side of the game board.

Example:

Since *Lin* has no cards or bonus markers left to use, she drops out of the Action phase.

First, she flips the face-down cards in her action area face up **1**.

Then she picks up 1 resting deck of her choice to return to her hand **2**.

Then she moves the cards from her action slots to her resting slots **3**, each to a different one.

Finally, she returns the field scientist tile to the area below the right side of the game board **4**.

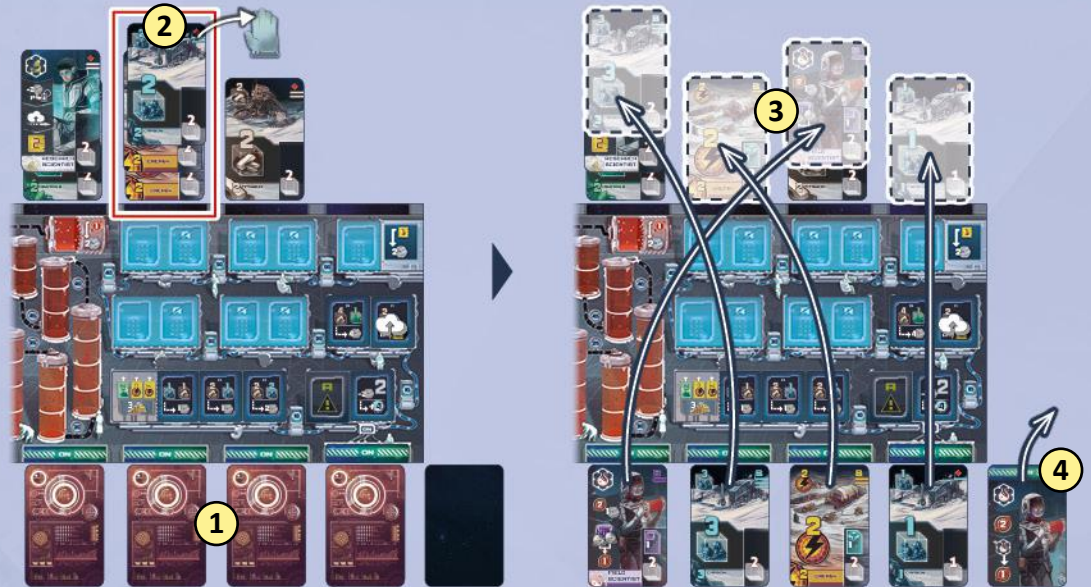

Players who have performed their “Drop out of Action phase” action are skipped for the rest of the Action phase.

Once the last remaining player has performed the “Drop out of Action phase” action, continue with the “Preparation phase for the next round”. After the Action phase of round 7, continue with the Final scoring phase.

3) Preparation phase for the next round

Carry out the following steps: a) Flip the next special research plan face up

b) Return the bonus markers to the players (including possible bonus tiles)

c) Fill up the card display

a) Flip the next special research plan face up

Look under the next round's special research plan on the round track and take the CrypCoin beneath it. Place the coin onto the hexagonal supplement space of the research display. (If there are already any CrypCoin on the supplement space, place the new one on top of them.) Then flip the next round's special research plan face up.

Example: At the end of round 3, in the preparation phase for round 4, the coin beneath the special research plan 4 is moved to the supplement space.



Then the special research plan 4 is flipped face up.

b) Return the bonus markers to the players (including possible bonus tiles)

Each player: Return all your bonus markers from bonus spaces to your reserve.

If you return any markers from bonus **tile** spaces, also gain the corresponding bonus tiles now and place them face up in your action area next to your action slots. (See page 20 for details on the bonus tiles.)

Example: Along with returning her bonus marker from the “Field scientist” bonus tile space to her reserve, **Lin** also takes the corresponding field scientist tile and places it face up in her action area.



c) Fill up the card display

First, remove all remaining cards in the **right column** of the card display (spaces 1 to 4) and place them face up onto the action card discard pile.

After that, slide the cards remaining in the middle and left columns as far right as they will go.

Finally, fill each empty space - going from the lowest number to the highest - with a face-up card drawn from the action card stack.

If the action card stack runs out, any remaining empty spaces in the display are not filled up any more.

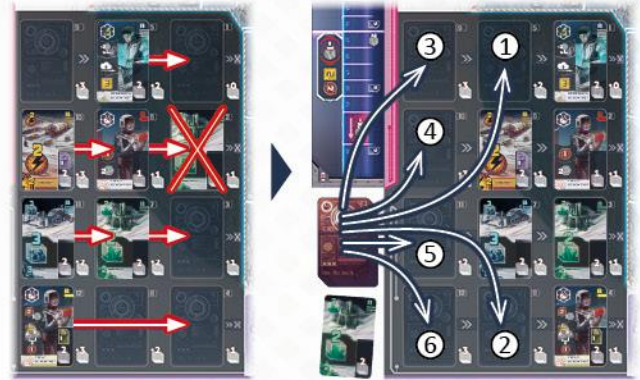

After these steps are finished, begin with the Planning phase of the next round.



The last 8 cards of the action card stack are **single share cards**. Depending on how many cards the players have acquired during the game, these single share cards enter the display sooner or later (or not at all). Each of these cards represents a single additional share of a specific company. Once acquired, a single share card remains in the hand of its owner until the Final scoring phase. It can never be placed in an action slot (as there is no action associated with it).

End of the game

For virtual scoring pads of all our games, get the **Deep Print Games app**:
<https://scoreapp.deep-print-games.com>



After the Action phase of round 7, the game ends. Now, the **Final scoring phase** takes place as follows:

Each player: First, pick up **all cards** of your resting decks and add them to your hand. Then find from your hand all cards that show an additional company share on their right side. Sort these by company and place them in front of you.



Now, one player takes the **scoring pad**. Go step by step through the 7 scoring categories, while that player writes down how much each player earns:

1) Write down the amount of CrypCoin each player has as **cash** in their reserve.

2) Then, turn to **Astrogo Enterprises** and calculate for each player the amount of CrypCoin they earn from the **shares** they have of Astrogo Enterprises. To do this, count the **number of uncovered coin icons** in Astrogo Station. Then, for each player, multiply this number by the **total number of shares** which that player owns of Astrogo Enterprises. Write the individual result of each player down.





Reminder: A player’s total number of shares of a company is equal to the last share icon that they reached on that company’s track + each additional share of that company they have on their cards (see also section “Object of the game” on page 9).

Repeat this for the shares of:

3)  Tawac Industries

4)  Skymine Resources

5)  and Minerva Corp.

6)  For each player, write down the **last value** their **helium-3 marker** has passed on their **tank track**.



7)  For each player, determine the **last value** which their **upload marker** has passed on their **research track**. Then add to it any values on face-up **special research tokens** that their upload marker has reached or passed. Write the individual result of each player down.

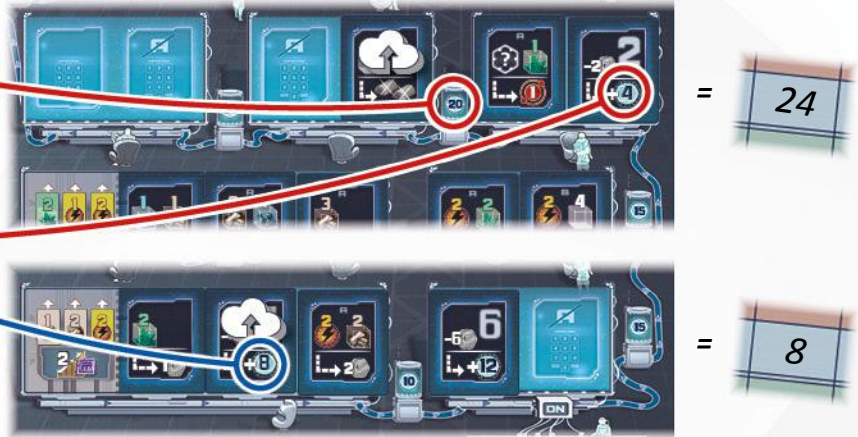

Finally, add up the earnings in the seven categories for each player. The player who earned the most CrypCoin in total wins the game. In the case of a tie, the victory is shared.

Further details

Details of the bonus tiles

You can reserve **bonus tiles** for the next round via the bonus tile spaces (see page 17). You receive them during the “Preparation phase for the next round” (see page 19) and must cede them again at the end of that round.

There are 4 bonus tiles:



“+1”-resource tile

When you receive the “+1”-resource tile, place it next to your player board and keep it there until the Action phase of that round. Then, during any of your **own turns of that Action phase**, place the “+1”-resource tile in the bottom right corner of any face-up **resource card** in your action area. From then on, the value of this resource card is increased by **1 unit** of that type.

- Once placed, you are not allowed to move the “+1”-resource tile to another resource card.
- After you have used the resource card with the tile, flip both face down.
- You cannot use the tile independently of a resource card.



This card counts as a 3-unit carbon card.

The following 3 bonus tiles are called **action tiles**. Action tiles are regarded as action cards of their type, except that they don't require empty action slots and instead are placed beside your other cards in your action area. They are flipped after use as usual.



Field scientist tile

When you use this tile, first move your helium-3 marker 2 spaces forward on your tank track. Then move your helium-3 marker **1 additional space forward for each further field scientist card** that is currently face up in your action area (excluding this field scientist tile).



Research scientist tile

This tile is used like any other research scientist card (but grants only 1 research point).



Energy tile

This tile is used like any other energy card and has a value of 2 energy points.

Details of the company tracks and their bonuses

Each company track has one or two **money barriers**. These are not considered spaces of that track but function as a link between two adjacent spaces. Whenever your track marker passes a money barrier, you **must** immediately pay the CrypCoin shown on it to the bank. If you cannot or do not want to, your track marker must stop and remain on the space before the money barrier.

If you reach the last space of a track, your track marker remains there for the rest of the game.

If you use a reward that lets you move forward on a specific track and you cannot use it completely (because of a money barrier which you cannot pay or the end of the track), move your marker as far as possible and forfeit the rest.

Each company track has 2 **bonus thresholds**. Whenever your track marker passes one, two things happen:

1. You gain from the bank the amount of CrypCoin shown beside it (1 or 2 CrypCoin).
2. Each player who has **already passed** it also gains that amount from the bank.

Example: Lin (♦) moves 3 spaces forward on company track A1 and passes the first bonus threshold. For this, she gains 1 CrypCoin from the bank.

Since Malik (○) and Amber (★) already have passed that threshold, they receive 1 CrypCoin from the bank as well.

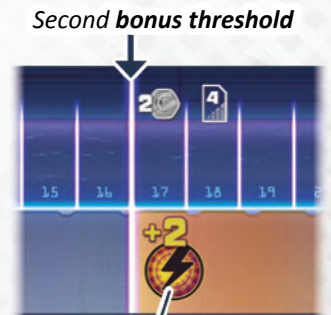
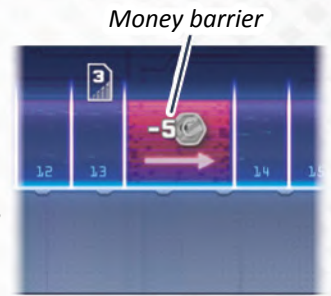

When you pass a bonus threshold, you also unlock its **track bonus**. This track bonus will take effect from your **next turn onward** (i.e. if you unlock it in the middle of an action, you cannot use it while carrying out that action).

There are 2 types of track bonus:

Permanent bonuses



and **bonus space bonuses**

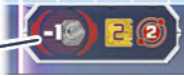

If you have unlocked a permanent bonus, you may use it each time you perform an action to which it is relevant.

Bonus space bonuses work exactly like the bonus spaces on the game board (i.e. you use them with the “Place 1 bonus marker” action).

Each track has 2 track bonuses. The second is usually an improved version of the first.

Important: If you’ve unlocked the second track bonus of a company track, you may use EITHER the second OR the first track bonus, but you **cannot** use both. This means:

- Permanent bonuses are not cumulative.
- If one of your bonus markers is already on one of the two bonus spaces of a company track, you are not allowed to place a second marker onto the other.

Permanent bonuses

The **total value** of energy points in your action area is increased by 1 or 2 for all intents and purposes (expanding a company, majority bonus spaces, research plan requirements, etc.). However, this bonus takes effect only if you have at least 1 energy card in your action area.

You have 1 or 2 **additional bonus markers** of your color which you can place as usual. (Take these bonus markers from those that were returned to the box during setup.)

Whenever you acquire a card from the card display by using **minerals resource cards** as a payment, the card’s total cost is reduced by 1.

Whenever you acquire a card from the card display, you can use a mix of any type of resource cards to do so. Also, the card’s total cost is reduced by 1.

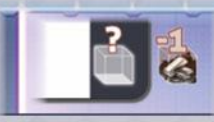

Each time you acquire a card from the card display by using **titanium resource cards** as a payment, the card's total cost is reduced by 1.



The value of **each titanium resource card** in your action area is increased by 1 for all intents and purposes.



This track bonus consists of 2 parts:

1. You now have a permanent field scientist icon (virtually located in your action area). You cannot actively use it, but it counts as an additional field scientist card when using the field scientist tile, when gaining the scientist bonus space reward and for meeting the requirements of research plans. *You always meet this research plan requirement now.*

2. Whenever you use any company's field scientist (e.g. the Astrogo field scientist), the number of gas collectors that this company controls is increased by 1. *If, for example, you use the Astrogo field scientist and Astrogo Enterprises controls 3 gas collectors on the board, they count as 4.*



The second track bonus is the same as the first (see above), but the number of gas collectors is increased by 3.

Bonus space bonuses



Requirement:
Pay 2 CrypCoin to the bank.

Reward: EITHER: Utilize 2 research points AND move your helium-3 marker 1 space forward on your tank track.
OR: Utilize 1 research point AND move 2 spaces forward on your tank track.



Requirement:
Pay 1 CrypCoin to the bank.

Reward: Immediately utilize 2 research points AND move 2 spaces forward on your tank track.



Requirement:
None.

Reward: Immediately buy 1 card from the card display by paying its total cost in CrypCoin to the bank (take the card into your hand) AND/OR move 1 space forward on your tank track.



Requirement:
None.

Reward: Immediately buy 1 card from the card display by paying its total cost reduced by 1 in CrypCoin to the bank (take the card into your hand) AND/OR move 2 spaces forward on your tank track.

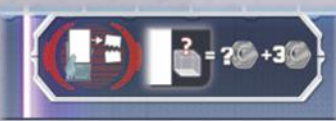

Requirement:
Remove 1 card from **your hand** by placing it face up onto the action card discard pile.

Reward: Immediately gain an amount of CrypCoin from the bank equal to the **cost** printed on the removed card + 3.



Requirement:
Remove 1 **carbon resource card** from **your hand** by placing it face up onto the action card discard pile.

Reward: Immediately gain an amount of CrypCoin from the bank equal to the **cost** printed on the removed card + 8.



Requirement:
Pay 1 CrypCoin to the bank.

Reward: Choose two company tracks (but not track D2 itself). Move your track marker on one of them 3 spaces forward and your track marker on the other 2 spaces.



Requirement:
Pay 1 CrypCoin to the bank.

Reward: Move your track markers on each of the other 3 company tracks forward (not track D2). Move 3 spaces on one, and 2 on each of the others.

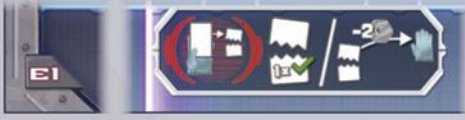

Requirement: Remove 1 card from **your hand** by placing it face up onto the action card discard pile.

Reward:

EITHER: Immediately perform the action corresponding to the discarded card's type. It cannot be combined with other action cards in your action area.
If, for example, the discarded card has 2 energy points, you must use them to expand one company. You cannot combine the card with other energy cards in your action area. However, if it is a research scientist card, you still count the cards in your action area towards the requirements of research plans.
 The permanent bonuses of other company tracks still apply when using the discarded card (as if it were in your action area).

OR: Pay 2 CrypCoin to the bank to add any card from the discard pile to your hand.

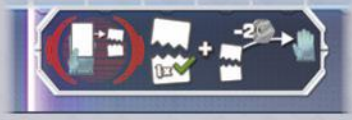

Requirement:

Remove 1 card from **your hand** by placing it face up onto the action card discard pile.

Reward:

Immediately perform the action of the discarded card AND/OR buy 1 card of your choice from the action discard pile (see left for details).

Special spaces of the player boards

If your helium-3 marker reaches the **final tank space**, it must stop and remain there for the rest of the game. However, from that moment on, whenever you receive any rewards that allow you to move forward on your tank track (including any excess movement when reaching the space), instead gain **2 CrypCoin** from the bank **for each space** you would have moved.

Once your helium-3 marker reaches **this space**, the additional action slot beneath it is switched on. Flip its **ON/OFF marker** to ON. You can use this slot starting with the **next Planning phase** (see section "Planning phase" on page 9).



If your upload marker reaches the research plan on the **final screen**, it must stop and remain there for the rest of the game. From now on, whenever you utilize research points, you must spend **each** of them to gain **2 CrypCoin** from the bank. (You are

no longer allowed to utilize research points in any other way.)

Once your upload marker reaches the research plan on **this screen**, the additional action slot beneath it is switched on. Flip its **ON/OFF marker** to ON. You can use this slot starting with the **next Planning phase** (see section "Planning phase" on page 9).

General game notes and further special cases

- When acquiring a card from the card display, you must always use at least 1 resource card (even if the total cost is zero). However, if the cost is zero, you can use all units of the resource value to advance on company tracks. A card's total cost can never drop below zero (even if a track bonus would make it do so).
- When you buy a card for CrypCoin via a bonus space and its total cost is zero (it cannot drop below zero), you do not have to pay any CrypCoin to take it. (But you still have to pay the possible cost of the bonus space itself.)
- If the research plan supply of a certain letter runs out, empty spaces of that letter in the research plan display are not filled up any more.
- The supply of CrypCoin is considered unlimited. If you run out, use something else as a replacement.

Gameplay variant: Linked slots

If you want to make the card planning aspect in the game more challenging, you can use the following variant:

Each action slot is linked to the resting slot in the same vertical line. This means that when you clean up your action area during the "Drop out of Action phase" action, you must move each action card from its action slot straight up to the resting slot in the same vertical line (instead of choosing in which resting slot to place it).



Campaign and modules

The campaign for *Skymines* comprises 4 chapters. Each chapter spans 1 game and has a specific setup which includes one or more of the modules. The rules for each module are explained at the end of the chapter in which the module first appears. If you want to play any of the modules independently of the campaign, just refer to the corresponding rule set under the module's heading.

You can use Luna to simulate an additional player for the campaign and modules, which is mandatory if you want to play solo. All rules regarding Luna can be found in the Luna booklet

Earning success points

Each player: At the end of each chapter of the campaign, you are awarded a number of success points (SP), which are calculated as follows:

- + 1 SP if at least one player earned fewer CrypCoin than you. (You don't get it if you're tied for the fewest CrypCoin.)
- + 1 SP if at least two players earned fewer CrypCoin than you. (You don't get it if you're tied for the second fewest CrypCoin.)
- + 1 SP if you are the winner of the chapter. (You get it if you're tied for the most CrypCoin.)
- + 1 SP if at least two of your one-time bonus markers are gone from your mission status card (see "Mission cards" on page 25).
- + 1 SP for **each** track (company tracks, tank track and research track), whose final space you've reached.

If there are further success points specific to a chapter, those are stated in that chapter.

Write down each player's success points in the bottom row of the score sheet.

Once all 4 chapters have been played, sum each player's success points. Whoever gained the most is crowned the overall winner (or in the case of a tie: the overall winners). Each player can also rate their individual success via this table:

- <7 SP Let's just say, you are very down-to-earth. Seems, space is just not for you.
- 7+ SP That was okay-ish! You've almost made it into space.
- 12+ SP Nicely done! You're more than halfway to the Moon.
- 17+ SP That was excellent! Next stop: Mars.
- 22+ SP Consider yourself legend! You've probed farther into the Solar system than anyone has before.

Chapter 1: Mining the Moon

Finally, the time has come. Years of keeping tabs on political developments and the resource market, of making costly preparations, of hiring specialists and of acquiring lab and mining gear will soon come to fruition. At long last, the Governmental Space Mining Agency is incapacitated. All its business has been nullified and its network of mines and stations abandoned. The sky ain't the limit any more. Everything out there is up for grabs.

I've already got my hands on a few mines and am in close contact with the independent companies that managed to get a head start in setting up stations on the Moon. They're all welcoming investors like myself in order to get an edge on each other. They are well aware that claiming as many sectors and remaining structures as possible will cause their stocks to skyrocket. And I want my fair share of the action...



Setup

Set the game up as in the basic game. **In step 3**, allot the company tracks at random via the track cards (option B). **In step 13**, deal each player 2 starting research tokens, of which they choose one (option B).

After setting the basic game up, also set up the module "Mission cards" (see next page).

Playing the game

Play the game as usual, following the normal basic game rules and the mission cards rules (see next page).

End of the game

Carry out the end of the game and the Final scoring phase as usual. Then write down the success points for each player as described above.

Module: Mission cards

Setup

- a** After setting the game up as usual, take the 6 **mission cards** and shuffle them face down. Depending on the number of human players (Luna doesn't count), place one or two mission cards face up next to the game board:
- If there are 1 or 2 human players, place 1 mission card.
 - If there are 3 or 4 human players, place 2 beside each other.



Front: Mission card

- b** *Each player:* Take 1 of the remaining face-down mission cards and place it in front of you so that the **mission status card** on its back is facing up. Then take your 3 **one-time bonus markers** and place them onto the 3 dashed spaces in the bottom part of your mission status card.

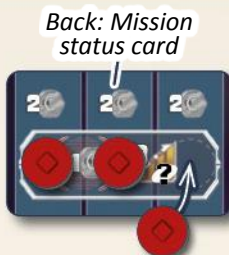

Finally, place your mission status card (with your 3 one-time bonus markers on it) in the area above the face-up mission card(s). Return any spare cards and one-time bonus markers to the game box.

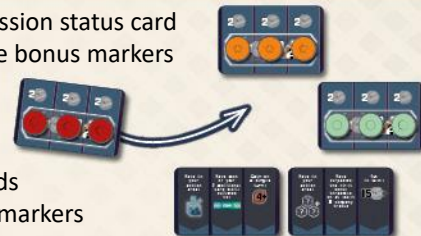

Playing the game

The game is played as usual. The mission cards do not change the normal rules but provide additional options.



Each mission card shows 3 tasks that you can fulfill.

If, during your turn, you meet the requirements of any task, you may take your mission status card (with your one-time bonus markers on it) and place it directly below that task's mission card so that their 3 columns align.



Afterwards, gain 2 CrypCoin from the bank.

Then take the one-time bonus marker in **that task's column** and place it in your reserve.

Your mission status card is now linked to that mission card and for the rest of the game you can only fulfill tasks in whose column you still have a one-time bonus marker. Again, on any of your turns, you can fulfill such a task to gain 2 CrypCoin and the corresponding one-time bonus marker.

Once you've fulfilled the last task and all of your one-time bonus markers are gone from your mission status card, also take the mission status card and place it next to your player board. You have now unlocked the **personal bonus space** on its bottom, which you can use for the rest of the game (by taking the "Place 1 bonus marker" action as usual). The other players cannot use your personal bonus space.

Requirement: Pay 1 CrypCoin to the bank.

Reward: Move your track marker 3 spaces forward on 1 company track of your choice.



Further notes and special cases:

- Each player is allowed to fulfill the tasks of one mission card. They are not blocked by the first player to do so. If you fulfill your first task and there are already one or more mission status cards below its mission card, just place your mission status card below them.
- When a mission status card is empty and thus removed from its mission card, just move any other mission status cards upwards to close the resulting gap.
- As their name suggests, **one-time bonus markers** can be used like regular bonus markers but only once. So when you place a one-time bonus marker on a bonus space, that marker is removed from the game during the next "Preparation phase for the next round".
- You can fulfill the tasks of a mission card in any order and on any of your turns (even several in the same turn). Some of them can only be fulfilled by meeting their requirement while performing a certain action. Others can be fulfilled in addition to performing an action. In any case, fulfilling a task is never considered an action itself.



The tasks on the mission cards should mostly be self-explanatory. The following tasks may need clarification:

Have in your action area:

You fulfill this task if you have at least 3 scientist cards face up in your action area (whether they are research and/or field scientists).

Have in your action area:

You fulfill this task if you have at least 7 units of **one** resource type face up in your action area.

Gain on a single turn:

You fulfill this task if in the course of one action, you move at least 4 spaces forward on your tank track.

Expand one company at least 5 times on a single turn

You fulfill this task if during one "Use all energy cards" action, you place at least 5 outposts from a company's station on the Moon.

On the Belt side of the board, you fulfill it if you place at least 5 pieces (outposts/shuttles) from a company's station on Belt spaces during that action.

End of the game

Carry out the end of the game and the Final scoring phase as usual.

Chapter 2: Into the Belt

Now that the Moon's stations have been up and running for several years, the companies that fought over its resources have set their sights on new horizons. And since the original mining network stretched far beyond the orbit of Mars, there are several promising regions with abandoned structures, most of them located within the Asteroid Belt between Mars and Jupiter. One region especially has us investors and the companies excited. And as they've just finished building their new stations there, glorious times are ahead. Granted, it took almost every last CrypCoin of my fortune to get here. The prospects, however, are so much greater. And I'm keen to see which company will emerge as the most valuable by spreading across the asteroids and taking control of the flight paths between them.



Setup

Set the game up as in the basic game but include the changes described in the setup section of the module "Belt side of the board" (see below). **In step 3**, allot the company tracks at random via the track cards (option B). **In step 13**, deal each player 2 starting research tokens, of which they choose one (option B).

Afterwards, also set up the module "Mission cards" (see previous page).

Playing the game

Follow the rules described below in the module "Belt side of the board" and the module "Mission cards" (see previous page).

End of the game

Carry out the end of the game and the Final scoring phase as usual. Then write down the success points for each player as described on page 24.

Module: Belt side of the board

Setup

Set the game up as in the basic game with the following changes during these steps:

2 Place the game board, Belt side up, in the middle of the table.

4 Place 12 **outposts** of each color onto their matching station: one onto each home space of the 2 outer columns. Return the spare outposts of each color to the game box.

Then take the 5 **shuttles** of each color and place them in the middle column of their matching station.

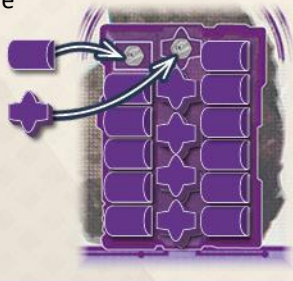

All other setup steps are identical to the basic game. Note, however, that the positions of the stations and company tracks are **inverted**. Bear this in mind when placing components beside the game board.



Playing the game

The game is played as usual. However, playing on the Belt side of the board entails changes to the following two actions:

The **"Use all energy cards"** action and the **"Use 1 field scientist card"** action.

2) Use all energy cards in your action area

With this action, you still expand the companies. However, now you place their outposts onto asteroids and their shuttles onto flight paths between those asteroids. Outposts of different companies can even share the same asteroids.

As usual, to perform this action, you must use **all** energy cards in your action area to expand **1 company** of your choice. Instead of entering sectors, however, you spend your energy points to enter **Belt spaces**.

There are two kinds of Belt space:

- **outpost spaces** on asteroids and
- **shuttle spaces** on **flight paths** between asteroids.

To enter a Belt space, carry out the following steps:

1. Choose a belt space that is **within reach** of the company you are expanding.

An **outpost space** is within reach if it's on an **asteroid** that:

- is attached to a flight path that contains a shuttle of that company or
- has an outpost of that company on any of its other outpost spaces.

A **shuttle space** is within reach if its flight path is attached to an asteroid that has at least one outpost of the expanding company.

As usual, you may enter belt spaces that contain outposts or shuttles of **other** companies.

2. Check whether it consumes 1, 2 or 3 energy points to enter the Belt space:

Entering a Belt space consumes **1 energy point** by itself (as shown by the printed  icon on it).

If - in order to reach that Belt space - you cross the part of a flight pass that has a  icon printed on it, it consumes **1 energy point** in addition.

And if there is already an outpost or shuttle of another company on that Belt space, it consumes **1 more energy point** to oust it.

3. If you have enough energy points to enter the Belt space, take the appropriate piece from the expanding company's station: outposts from the top of either outer column, shuttles from the top of the middle column.

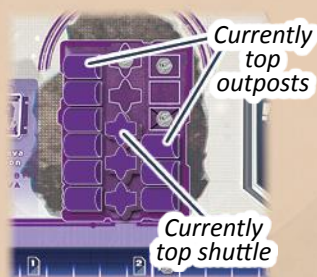

4. Place the outpost or shuttle onto the Belt space. As usual, place outposts upright for now and do the same with the shuttles (to mark that you have not yet received rewards). If there is a piece of another company on the entered Belt space, mark its ousting by sliding that piece a bit over so that it lies beside the Belt space for now.



Repeat steps 1 to 4 until you've spent all your energy points. If you cannot or do not want to spend all of them, you must forfeit any excess.

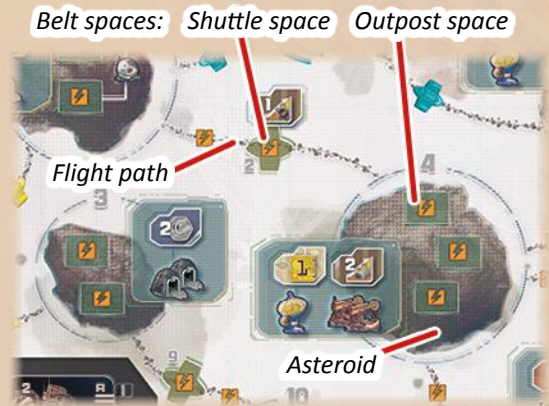

Example:

Lin uses her total of 6 energy points to expand Minerva Corp.

First she enters shuttle space 19 (**a**), which consumes 1 energy point. She marks this with the top shuttle taken from Minerva Station (**a**).



She then enters the empty outpost space (**b**) on asteroid 14. This consumes 2 energy points, because the part of the flight path she uses to get there shows an additional  icon. She marks the outpost space with an outpost taken from Minerva Station (**b**).

Next, she chooses to enter shuttle space 13 (**c**). This consumes 2 energy points (1 for entering the shuttle space and 1 for ousting the pink shuttle). Again, she marks this with a shuttle taken from Minerva Station (**c**).

Now *Lin* has 1 energy point left which she uses to place an outpost (**d**) onto the empty outpost space on asteroid 18 (**d**).



Once you have finished spending your energy points, carry out the following steps:

1. Gain your **rewards** for expanding the company:

- For each shuttle space you entered which shows this reward icon, —————>  move your marker 1 space forward on the track of **the company you just expanded**.
- For each asteroid on which you just placed the **first** outpost(s) of that company (i.e. the expanding company did not have an outpost there right before your expansion), gain the rewards shown on that asteroid's **reward screen**. (This means, whenever further outposts of the same company are placed on the same asteroid, its rewards cannot be gained again.)



Take the rewards in any order, regardless of the order in which you entered the Belt spaces. (For details of the rewards, see "The structures and their rewards" on page 13.)

2. Return any outposts and shuttles that you ousted to their stations. Place shuttles on the lowest vacant space of their column. Place outposts on the lowest vacant space of the outer column of your choice. Remember that you can never return outposts/shuttles to any of the **crossed out home spaces**. Instead, return the outpost/shuttle to the next vacant home space above it.

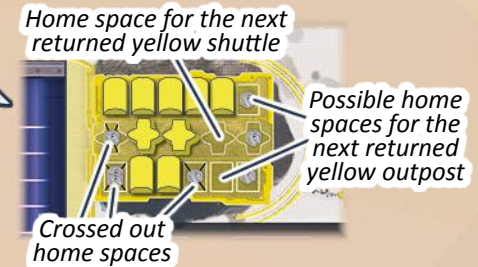
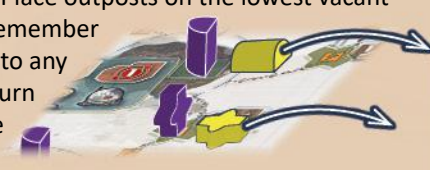

3. Once ousted outposts and shuttles have been returned to their stations (there can be no more than one piece on each Belt space now), tip over the upright outposts and shuttles so that they occupy their belt space correctly.



4. Finally, flip all energy cards in your action area face down. Then your turn ends.

Example (continued):

After **Lin** finishes expanding **Minerva Corp.**, she gains the rewards for doing so:

She gains the rewards shown on the reward screen of asteroid 14 **(a)** (1 research point + 1 CrypCoin).

She also gains the reward of shuttle space 13 **(b)** (moving 1 space forward on the **Minerva** track).

She does not gain the rewards shown on the reward screen of asteroid 18 **(c)** because an outpost of **Minerva Corp.** was already present on that asteroid before **Lin's** action.

Then she returns the ousted pink shuttle **(d)** to **Astrogo Station**, lowers the upright outposts and shuttles, and finally flips the energy cards in her action area face down.

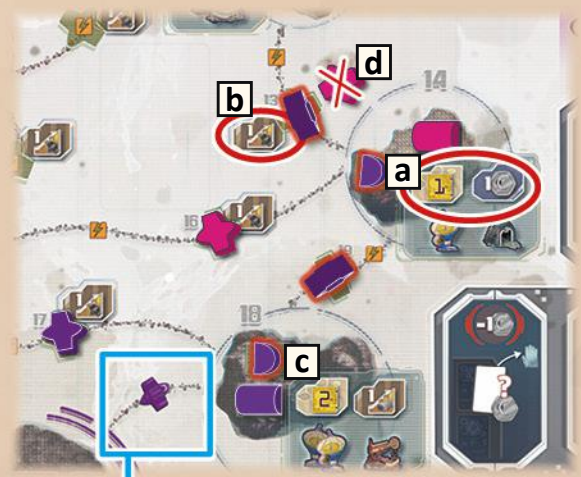

Further notes and special cases:

- Each flight path between a station and an asteroid already contains a printed **shuttle of the corresponding company**. This stays for the entire game. You can't place any shuttles on these flight paths.
- If there are no shuttles left in a station, this company cannot claim any other flight paths until shuttles are returned by ousting. If there are no shuttles and outposts left in a station, this company cannot be expanded until any of its pieces are returned by ousting. If a company runs out of options for placing outposts/shuttles while you expand it, you must forfeit any remaining energy points.
- If you need to return an ousted outpost or shuttle to its station but there is no valid vacant home space left, remove that piece from the game entirely.
- If you only have one energy card and its energy points are not enough to enter any Belt space, you must forfeit them entirely.



4) Use 1 field scientist card in your action area

This action works almost as usual (see page 16). Only the manner in which you calculate how many gas collectors a company controls is different:

A company controls any gas collectors shown on reward screens of asteroids where it has at least one outpost (no matter how many outposts of other companies are there).



It may control additional gas collectors on asteroids 1 and 15: If the company has an outpost on **both outpost spaces** that are linked to the same gas collector, that gas collector is also controlled by that company.

Example: *Lin* uses the Minerva field scientist to move her helium-3 marker the basic 2 spaces forward and to take 1 CrypCoin from the bank.



Then she checks how many gas collectors are controlled by Minerva Corp. Minerva Corp. has outposts on asteroids 10 and 15. Also, two of them cover both outpost spaces that are linked to a further gas collector. Therefore Minerva Corp. controls a total of 3 gas collectors, which means that *Lin* moves her helium-3 marker 1 additional space forward.



Attention: When playing on the Belt side of the board, bear the following in mind:

Whenever an icon shows an outpost ( / ) it means only **outposts**. It **never** includes shuttles.

End of the game

Carry out the end of the game and the Final scoring phase as usual.

Chapter 3: Return to the Moon

Decades have past. And while we were focusing on the Belt and its exciting opportunities, things started to fall apart. Everyone involved had to learn the hard way how difficult it is to keep alive a network that spans hundred millions of miles. We are close to collapse. I had to ditch most of my assets, and in order to get back on my feet, I'm returning to where it began: the Moon. Upon my return, however, I learn that the magnitude of the disintegration is greater than expected. Half of the sectors could not be maintained and the value of the companies has suffered a lot. But this also creates opportunity for new progress, and this time, we're gonna make it stick.

Setup

Set the game up as in the basic game. **In step 3**, allot the company tracks at random via the track cards (option B). **In step 13**, deal each player 2 starting research tokens, of which they choose one (option B).

Afterwards, also set up the module "Mission cards" (see page 25).

Once everything is set up, take from each station the **top outpost of each column** and place them on the game board as follows:

-  Place the 3 outposts of Sky mine Resources in sectors 6, 19 and 20.
-  Place the 3 outposts of Minerva Corp. in sectors 16, 21 and 23.
-  Place the 3 outposts of Astrogo Enterprises in sectors 1, 7 and 11.
-  Place the 3 outposts of Tawac Industries in sectors 2, 3 and 4.



Playing the game

Play the game as usual, following the normal basic game rules and the mission cards rules.

End of the game

Carry the end of the game and the Final scoring phase out as usual. Then write down the success points for each player as described on page 24.

In this chapter, one player can earn the following additional success point:

+ 1 SP if you are the first player during the game to unlock the personal bonus space on their mission status card.

Chapter 4: Lurking in the Belt

It's funny how a mindset can be rewritten, once things look up again. Redeveloping the Moon has been going far better than anyone could have hoped for. And though I promised myself in my old age never to risk all of this prosperity again - I'm feeling drawn out there once more. Maybe, I'm just bored and yearn for one last adventure. But the companies rediscovered a developed region in the Belt that was long forgotten. And probably rightfully so. The prospects seem phenomenal but it's also said that there is danger lurking among those asteroids. Whatever it is, I've already traded my current wealth for the chance to conquer one last part of our Solar system and become the legend I was meant to be.



Setup

Set the basic game up including the changes described in the setup section of the module "Belt side of the board" (see page 26). **In step 3**, allot the company tracks at random via the track cards (option B). **In step 13**, deal each player 2 starting research tokens, of which they choose one (option B).

Afterwards, also set up the module "Mission cards" (see page 25) and the module "Threat cards" (see below).

Playing the game

Follow the rules as described in the module "Belt side of the board" (see pages 26 to 29), the module "Mission cards" (see page 25) and the module "Threat cards" (see below).

End of the game

Carry out the end of the game and the Final scoring phase as usual. Then write down the success points for each player as described on page 24.

In this chapter, one player can earn the following additional success point:

+ 1 SP if you are the player who removed the threat card from the game board.

Module: Threat cards

Note: This module can only be played on the Belt side of the board.

Setup

- a** After setting the game up as described in the module "Belt side of the board", shuffle the 6 **threat cards**. Draw **one** and place it face up between **shuttle spaces 11 and 16** on the game board. Make sure that the flight paths in the corners of the card align with these two shuttle spaces.

Return the spare threat cards to the game box.



Playing the game

The game is played according to the usual Belt side rules with one addition:

The card in the game board's center poses a threat. This threat entails a specific **consequence** that affects all players at the end of the game. However, in order to negate that consequence for all players, the threat can be dealt with during the game. This can be done by any player during one of their "Use all energy cards" actions as follows:

1. To deal with the threat, you must be expanding a company whose shuttle is on shuttle space **11** or **16** (it doesn't matter if it was put there during the current expansion or if it was there before).
2. You must spend 2 of your energy points to reach the threat.
3. You must meet its **requirement**, which can be an additional cost or something else (see the list below).

Once you have finished expanding and have dealt with the threat, first collect any rewards as usual. Then collect the **reward** of the threat card itself, which includes removing the threat card from the board and flipping it face down.

On its back, it shows a **wild share**, which you place in front of you until the end of the game.

Once the threat card is gone from the board, the game continues as usual. No new threat is added to the board.

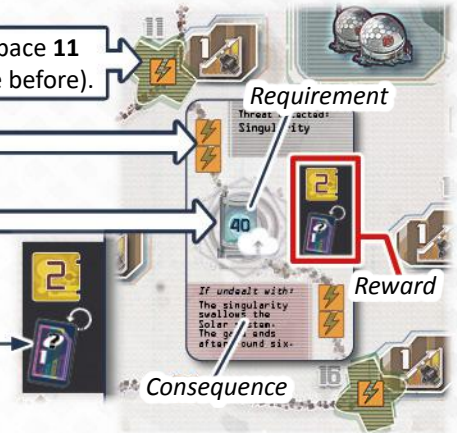

End of the game

Carry out the end of the game and the Final scoring phase as usual if the threat card has been removed during the game. The player who has the wild share in front of them counts it as a share of **one** company of their choice.

If the threat card is still on the board at the end of the game, you must apply its **consequence**. This consequence may affect the end of the game itself or certain aspects of the Final scoring phase (see the list below). Everything else is handled as usual.

List of threat cards:

<p>Threat detected: Space pirates</p> <p>Requirement: Pay 6 CrypCoin to the bank.</p> <p>Consequence: If the threat card is on the board at the start of the Final scoring phase, all players must return to the bank the CrypCoin they have in cash. Therefore, no one scores in the first category.</p> <p><i>If undealt with:</i> All players lose their cash.</p>	<p>Threat detected: Rogue comet</p> <p>Requirement: Spend another 3 energy points.</p> <p>Consequence: If the threat card is on the board at the start of the Final scoring phase, determine which company shows the most uncovered coin icons in its station. Ignore 2 of these coin icons when scoring that company. (If there is a tie for the most coin icons, do this for each tied company.)</p> <p><i>If undealt with:</i> The comet hits the most valuable station and decreases its value by 2.</p>	<p>Threat detected: Artificial Einstein-Rosen bridge</p> <p>Requirement: Remove 2 energy cards from your hand by placing them face up onto the action card discard pile.</p> <p>Consequence: If the threat card is on the board at the start of the Final scoring phase, all players must remove all energy cards they own by placing them onto the action card discard pile.</p>
<p>Threat detected: Probe with unknown signature</p> <p>Requirement: Your helium-3 marker must have surpassed value 40, which is printed on your tank track.</p> <p>Consequence: If the threat card is on the board at the start of the Final scoring phase, all players must remove their helium-3 marker from their tank track. Therefore, no one scores in the sixth category.</p> <p><i>If undealt with:</i> The probe annihilates the Helium-3 reserves on everyone's tank tracks.</p>	<p>Threat detected: Singularity</p> <p>Requirement: Your upload marker must have surpassed value 40, which is printed on your research track.</p> <p>Consequence: If the threat card has not been removed by the end of the Action phase of round 6, the game ends at this point and the Final scoring phase is carried out.</p> <p><i>If undealt with:</i> The singularity swallows the Solar system. The game ends after round six.</p>	<p>Threat detected: Time anomaly</p> <p>Requirement: Your helium-3 marker must have surpassed the printed value 25 and your upload marker the printed value 20 on their tracks.</p> <p>Consequence: If the threat card is on the board at the start of the Final scoring phase, carry everything out as usual and write down the scores (and success points if you're playing the campaign). However, there is no winner yet. Come together for another session of the game (in which you use this threat card again and the usual random setup). At the end of that game, also carry the Final scoring phase out as usual and so on. After the session during which this threat card is finally removed, calculate your final results by adding up your scores from all the games you spent in the time loop and dividing them by the number of those games. Round up any fractions. (Your final success points for this chapter are calculated the same way).</p> <p><i>If undealt with:</i> You get caught in a time loop. Play again!</p>

Overview of selected icons

 = Research scientist card

 = Field scientist card

 = Either scientist card

To meet this requirement, you need to have at least 1 field or research scientist card face up in your action area. **However**, if it is a research scientist card, it **cannot** be the one that is currently advancing your upload marker.



Move your helium-3 marker this many spaces forward on your tank track. (Follow the arrows of your tanks. If you move it through a pipe, follow the arrows to the next tank.)

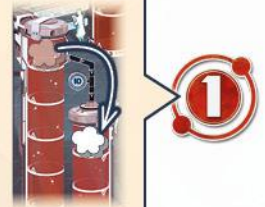

Utilize this many research points to acquire research plans from the research display and/or CrypCoin from the bank (see page 14).



Move your marker this many spaces forward on the track of **the company you just expanded** during a "Use all energy cards" action.



Move your marker this many spaces forward on the **Astrogo company track**.



Move your marker this many spaces forward on **one company track of your choice**.



Remove 1 outpost from the **station of a company of your choice** and return it to the game box. You may remove it from any column, but it must be the **top** outpost in that column (the one closest to the center of the game board). When playing on the Belt side of the board, shuttles cannot be removed this way.

To meet this requirement, you need to have at least 4 units of **one resource type** face up in your action area (at least 4 titanium units and/or 4 carbon units and/or 4 minerals units).



Following the rules above, remove 2 outposts from any stations.

To meet this requirement, you need to have at least 3 units of **carbon** AND at least 3 further units of **one** resource type face up in your action area.

(You meet the requirement if you have at least:

3 carbon units + 3 titanium units

OR 3 carbon units + 3 minerals units

OR 6 carbon units).



Pay this many CrypCoin from your reserve to the bank.



Gain this many CrypCoin from the bank.



To meet this requirement, you need to have at least 1 titanium unit face up in your action area.



If your upload marker stops on this research plan, gain from the bank an amount of CrypCoin equal to the **total value** of titanium that you have face up in your action area reduced by 1. (For example, if your total value of titanium is 6 units, you gain 5 CrypCoin, if it is 1 unit, you gain nothing).

We wish to thank all testplayers, especially Michael Gantner, Gerhard Heinze, Peter Hofbauer, Wolfgang Lehner, Stefan Widerin, Franziska Molter, Regina Molter, Andreas Molter, Ole Schlaack, Peter Schmähler, Carsten Burak, Sören Textor, and the Spielekreis Wien. Special thanks go to the Hippodice Spieleclub e.V.



Game design: Alexander Pfister, Viktor Kobilke
Artwork: Javier Inkgolem
Development: Viktor Kobilke, Peter Eggert
Editing and rule book: Viktor Kobilke
Proofreading: Neil Crowley

© 2022 Deep Print Games GmbH,
 Sieglindestr. 7, 12159 Berlin, Germany.
 All rights reserved.

www.deep-print-games.com

Distribution:

Pegasus Spiele GmbH,
 Am Straßbach 3,
 61169 Friedberg, Germany.



Pegasus Spiele

v1.0 All rights reserved. Reprinting or publishing of the rule book, game components, or illustrations is prohibited without prior permission.

Playing is Passion!
www.pegasusna.com



[/pegasusspieleNA](https://www.facebook.com/pegasusspieleNA)